



BERGAMONT

RIDE, FOLD, GRAB & GO.

PAUL-E



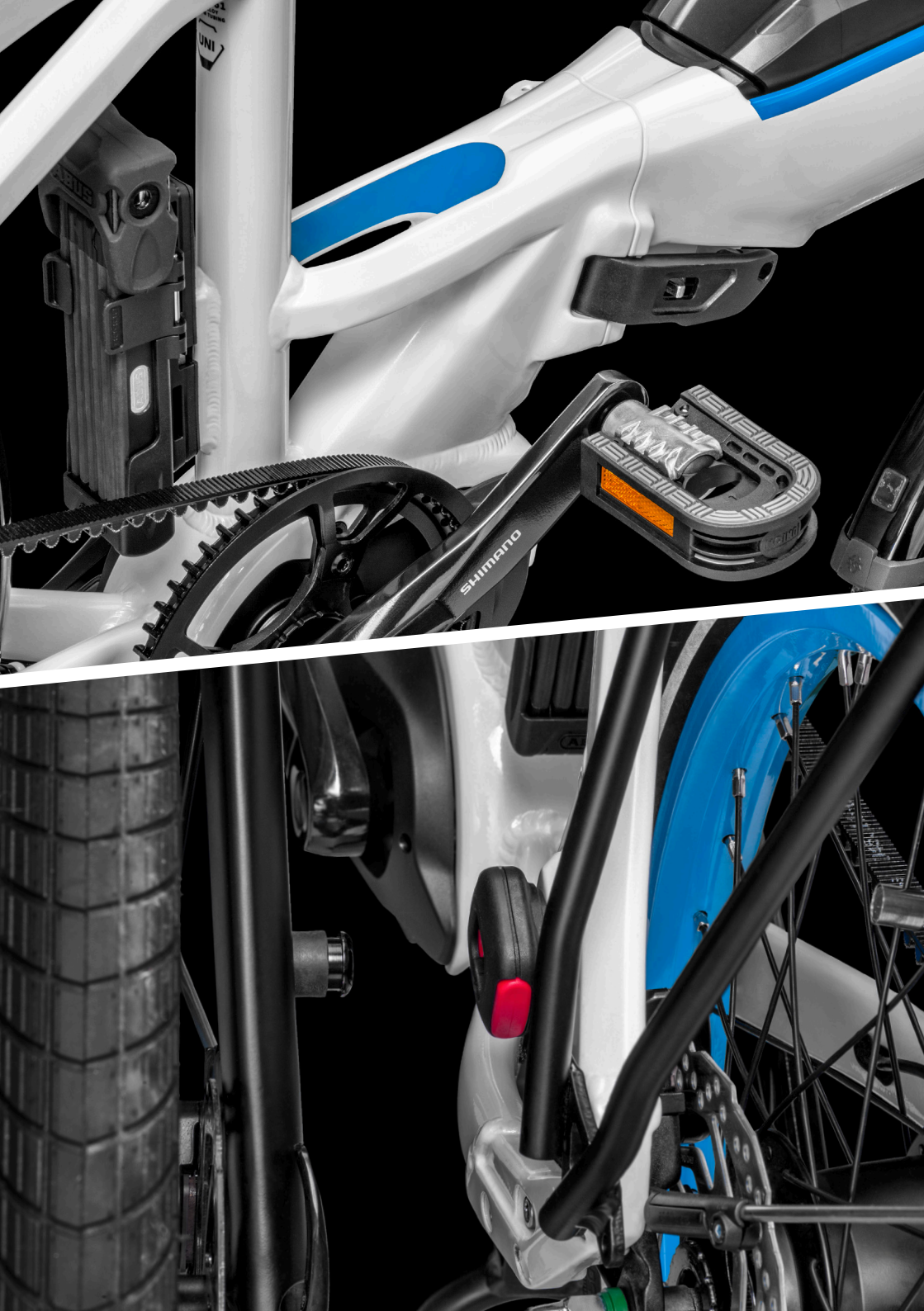

BERGAMONT PAUL-E

FALTANLEITUNG (DE)

FOLDING INSTRUCTIONS (EN)

INSTRUCTIONS DE PLIAGE (FR)

INSTRUÇÕES DOBRÁVEIS (ES)

INSTRUCCIONES DE PLEGADO (PT)

ISTRUZIONI PER LA PIEGATURA (IT)



Haftungshinweis (DE) / Notice on responsibility (EN) / Avis concernant la responsabilité (FR) / Aviso sobre responsabilidade (PT) / Aviso de responsabilidad (ES) / Avviso di responsabilità (IT)

► DEUTSCH (DE)

Wir empfehlen ausdrücklich, das folgende Produkt nur von den autorisierten Händlern installieren zu lassen. Wir müssen Sie darauf hinweisen, dass unsachgemäße Wartung, Reparatur und Installation zu Schäden an Ihrem Produkt und zum Erlöschen Ihrer Garantiesprüche gegenüber BERGAMONT führen können. Im Zweifelsfall lassen Sie diese Arbeiten von Ihrem BERGAMONT-Händler ausführen. BERGAMONT bemüht sich, die Informationen in dieser Montageanleitung aktuell und genau zu halten. Wir geben jedoch keine Garantie oder andere Zusicherung und können in keiner Weise für den Inhalt der in dieser Anleitung genannten Artikel, deren Richtigkeit, Vollständigkeit, Zeitlosigkeit oder Eignung für einen bestimmten Zweck haftbar gemacht werden.

► ENGLISH (EN)

We strongly recommend that this product should only be installed by an authorised dealer. We should point out that improper maintenance, repair or installation may damage your product and void its BERGAMONT guarantee. If in doubt, please ask your BERGAMONT dealer to carry out the work. BERGAMONT makes every effort to keep the information in these assembly instructions up to date and accurate. However, we do not give any warranty or other assurance, and may not be held liable in any way, as to the content of the items appearing in this manual, its accuracy, completeness, timelessness or appropriateness for any particular purpose.

► FRANÇAIS (FR)

Nous recommandons vivement que le produit suivant ne soit installé que par des revendeurs agréés. Il convient de souligner que l'entretien, la réparation ou l'installation incorrectes pourront endommager votre produit et annuler la garantie accordée par BERGAMONT. En cas de doute, adressez-vous à votre revendeur BERGAMONT pour la réalisation de ces travaux. BERGAMONT s'efforce d'assurer la mise à jour et la précision des informations comprises dans ces instructions de montage. Cependant, nous ne donnons aucune garantie ou autre assurance et ne pouvons être tenu responsable quant au contenu des éléments figurant dans ce manuel de part leur exactitude, leur exhaustivité, leur caractère intemporel ou leur adéquation à un usage particulier.

► PORTUGUÊS (PT)

Recomendamos vivamente que este produto seja instalado exclusivamente por revendedores autorizados. Devemos salientar que a manutenção, reparação ou instalação inadequadas poderão danificar o seu produto e invalidar a garantia do mesmo concedida pela BERGAMONT. Em caso de dúvida, solicite a realização destes trabalhos ao seu revendedor BERGAMONT. A BERGAMONT desenvolve todos os esforços para manter as informações incluídas nestas instruções de montagem atualizadas e precisas. No entanto, não concedemos qualquer garantia nem podemos de forma alguma ser responsabilizados pelo conteúdo do presente manual nem pela sua exatidão, integridade, intemporalidade ou adequação para um fim específico.

► ESPAÑOL (ES)

Le recomendamos encarecidamente que sea exclusivamente un revendedor autorizado quien instale este producto. Hemos de recalcar que un mantenimiento, reparación o instalación inadecuados podrían dañar su producto e invalidar la garantía que BERGAMONT le ha otorgado. En caso de duda, solicite al revendedor BERGAMONT que realice estas tareas. BERGAMONT lleva a cabo todos los esfuerzos posibles para que la información incluida en estas instrucciones de montaje esté actualizada y sea precisa. Sin embargo, no concedemos garantía alguna, ni podemos de ninguna forma responsabilizarnos del contenido de este manual en lo referente a su exactitud, integridad, intemporalidad ni adecuación a un fin específico.

► ITALIANO (IT)

Si raccomandiamo in modo assoluto che questo prodotto venga installato solo da rivenditori autorizzati. Dobbiamo evidenziare che la manutenzione, la riparazione o l'installazione non adeguate potrebbero danneggiare il suo prodotto e annullare la garanzia dello stesso concessa dalla BERGAMONT. Se ci fossero dei dubbi, richiedete lo svolgimento di questi lavori al vostro rivenditore BERGAMONT. La BERGAMONT fa tutti gli sforzi possibili per mantenere aggiornate e precise le informazioni comprese in queste istruzioni di montaggio. Tuttavia, non concediamo alcuna garanzia e non possiamo in alcun modo essere considerati responsabili per il contenuto di questo manuale né per la relativa esattezza, integrità, atemporalità o adeguatezza per un fine specifico.

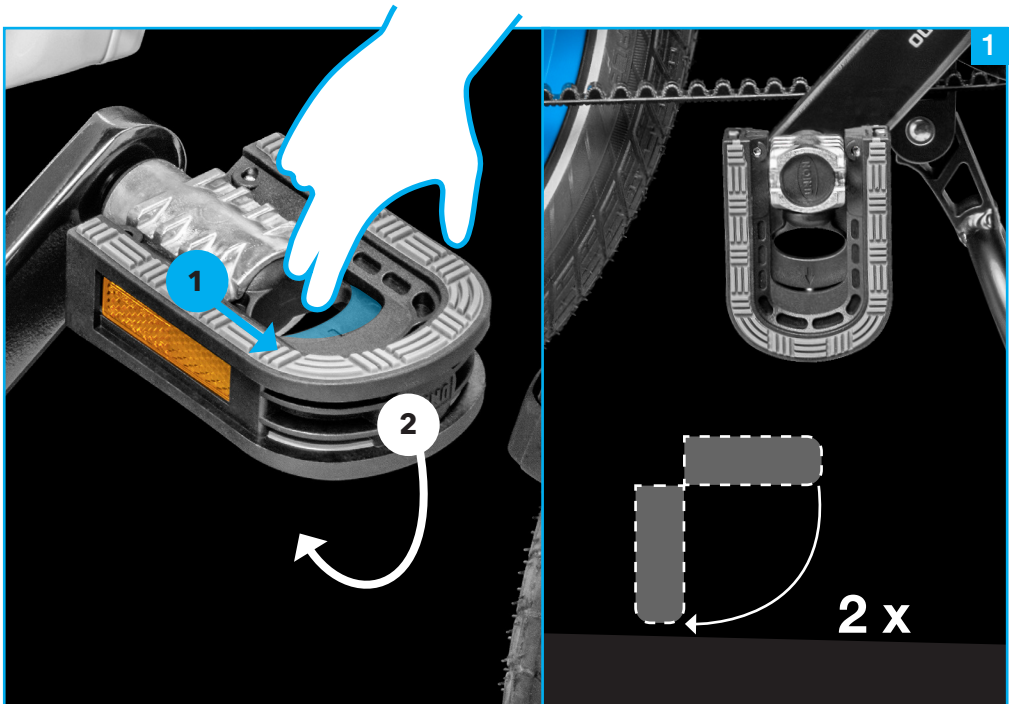

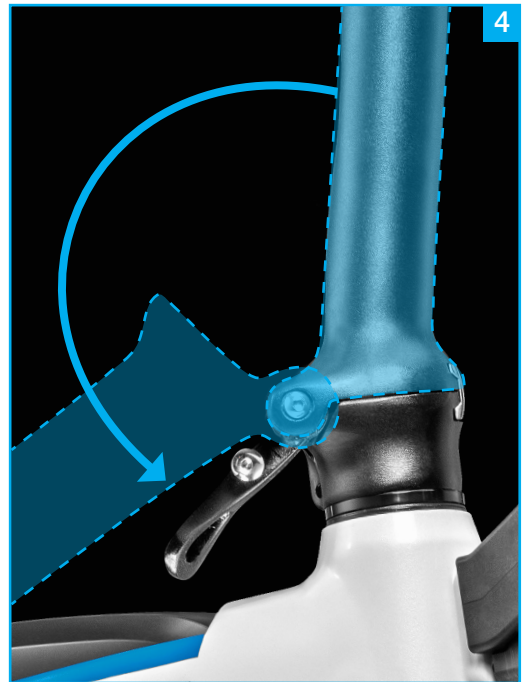
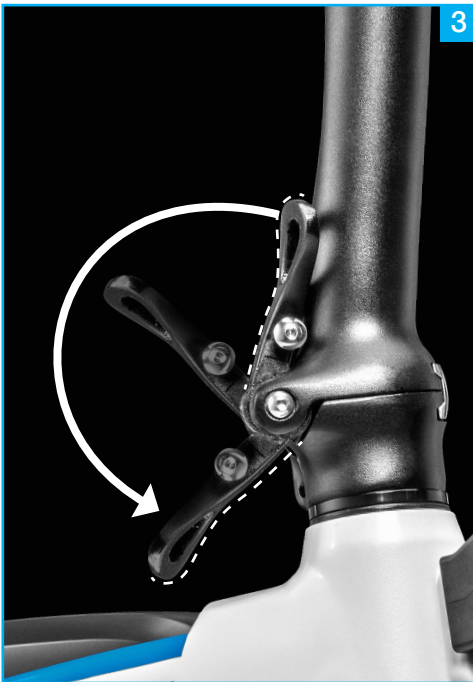
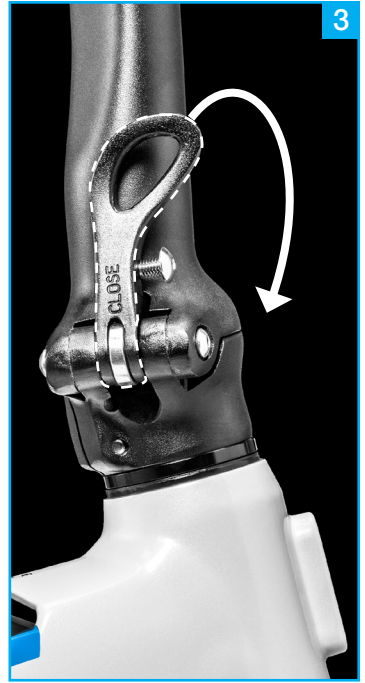

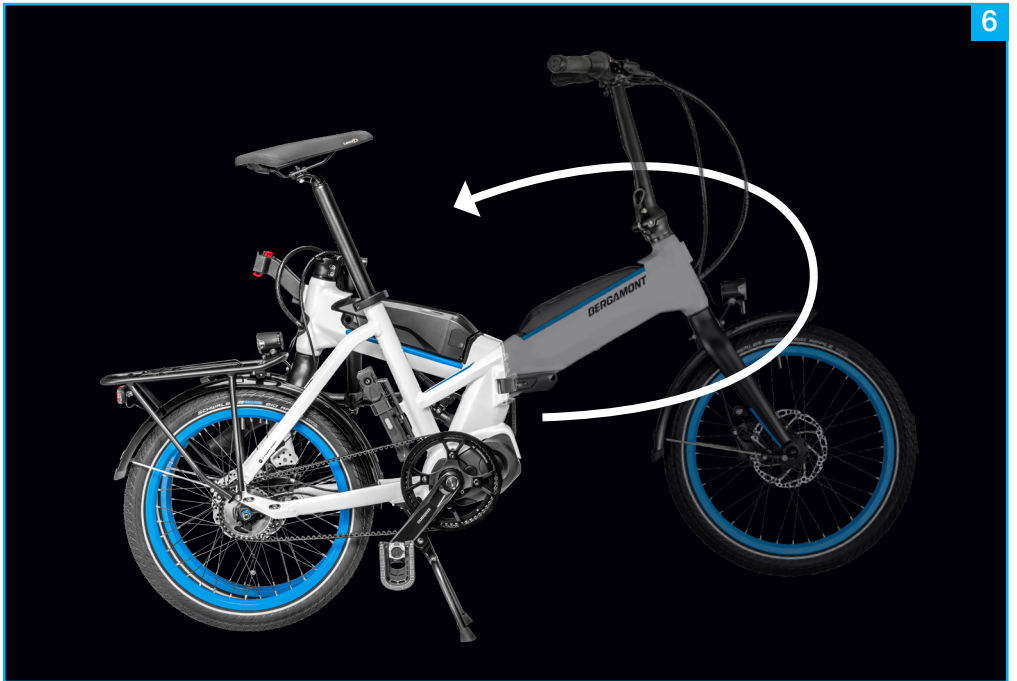
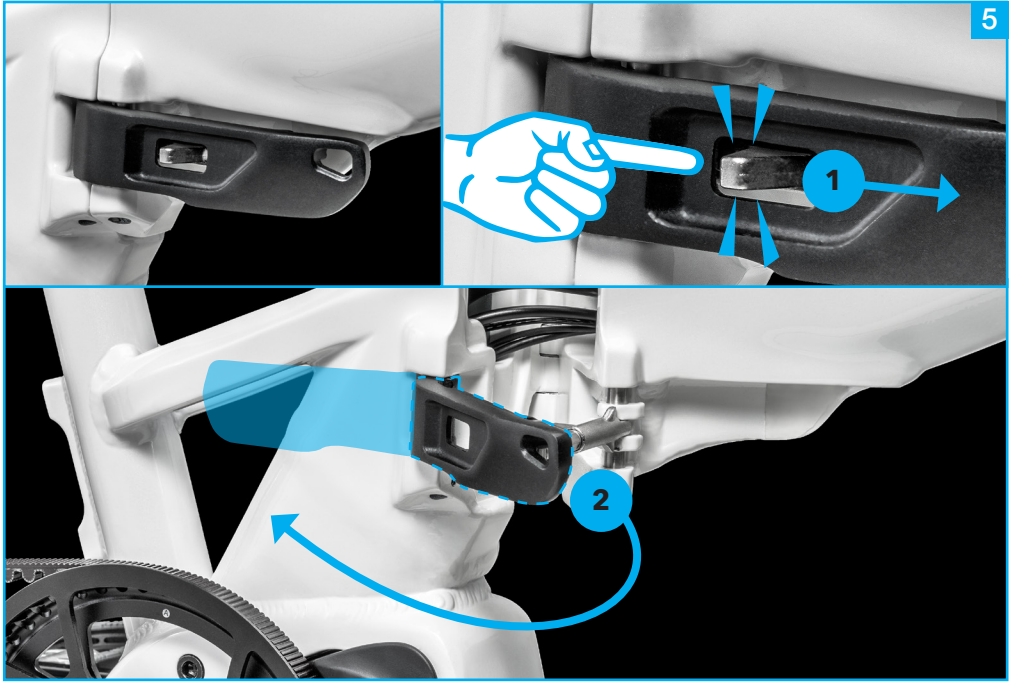

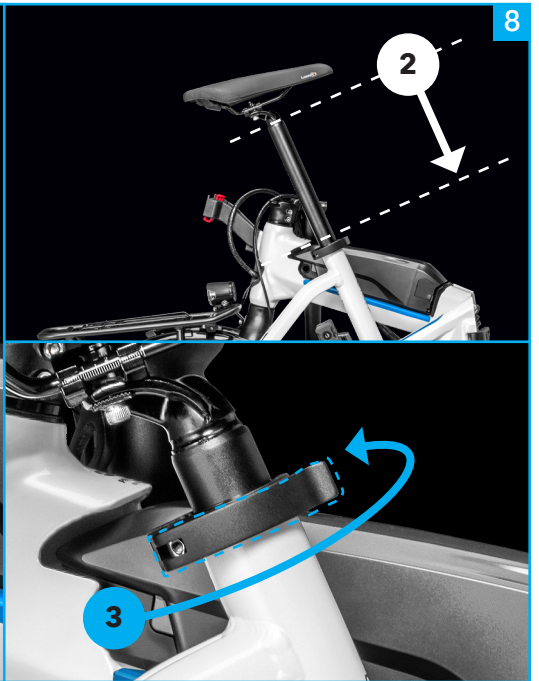
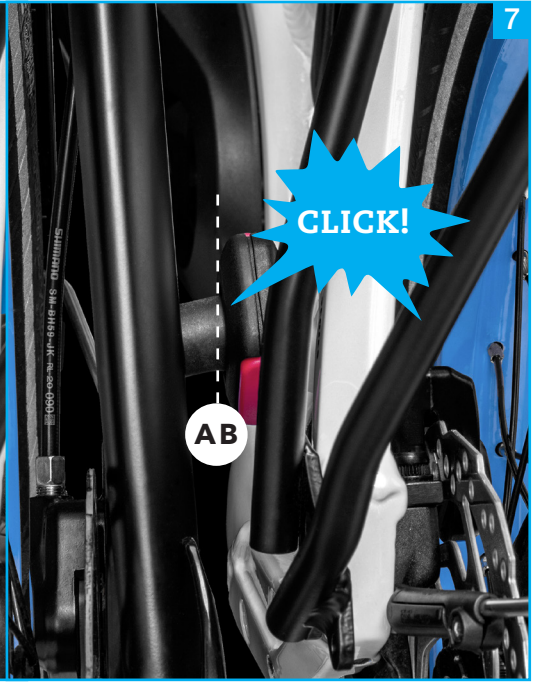
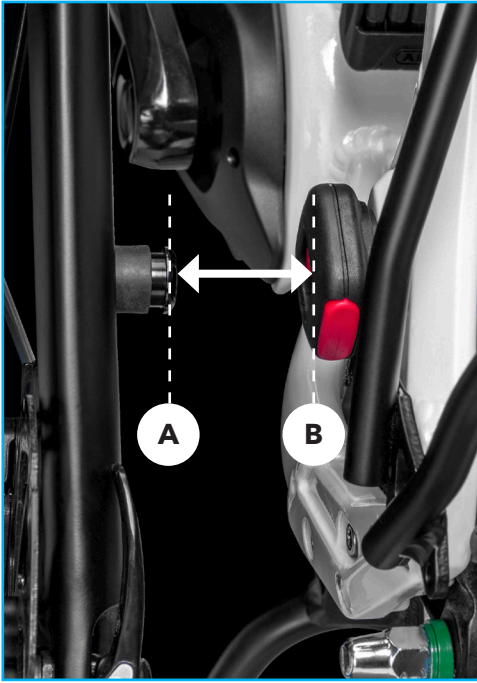

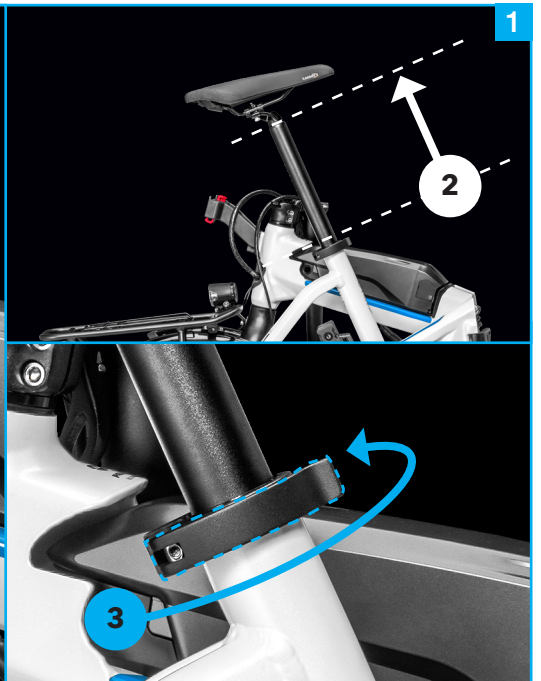

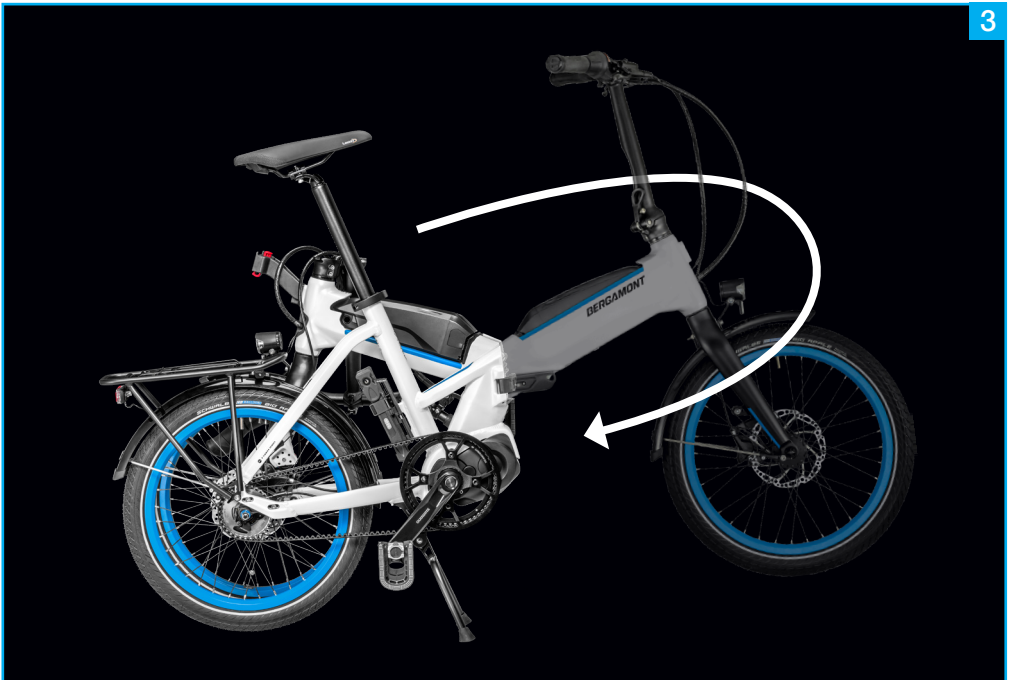
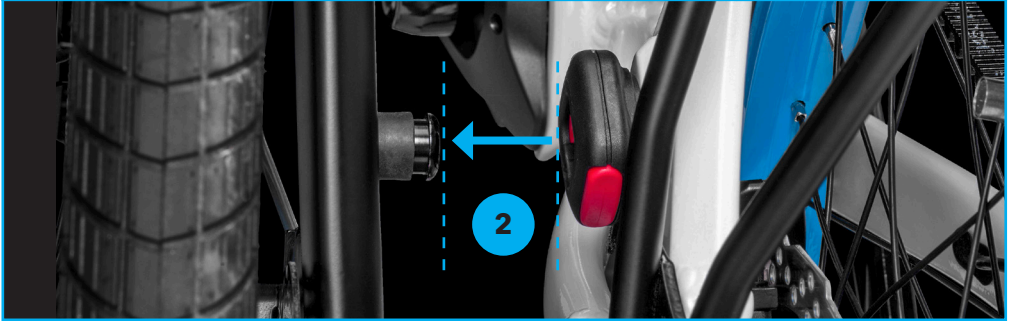

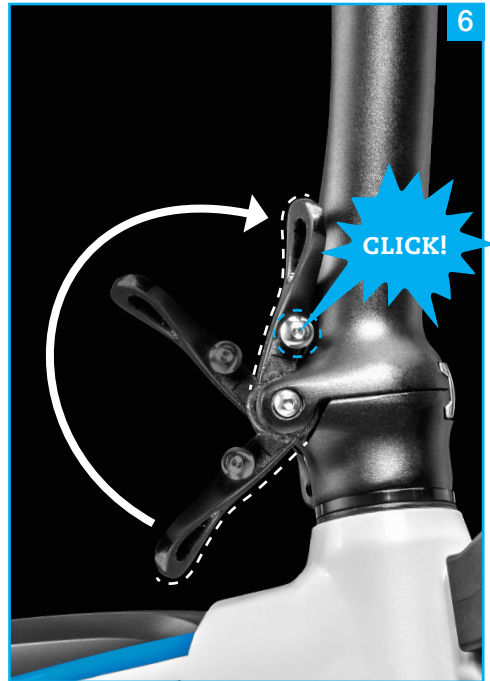
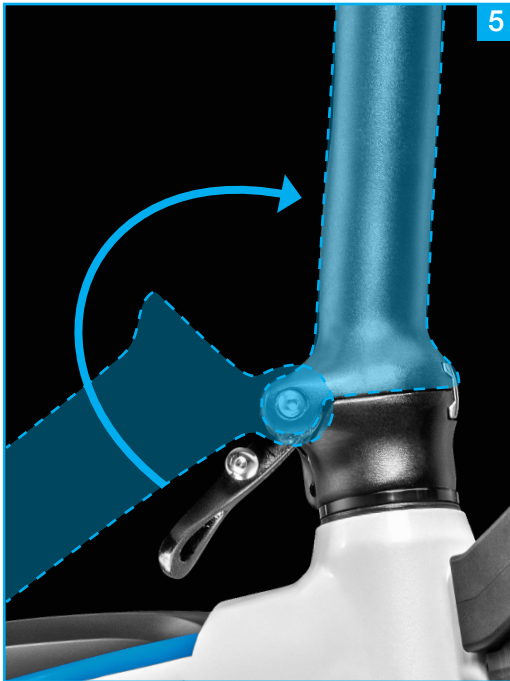
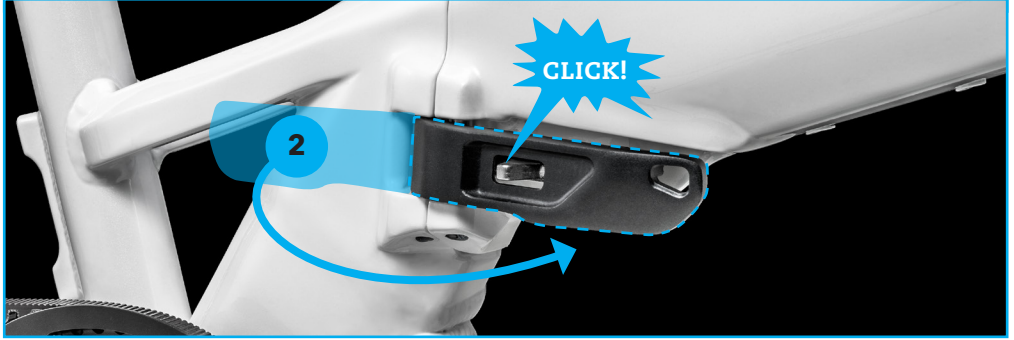
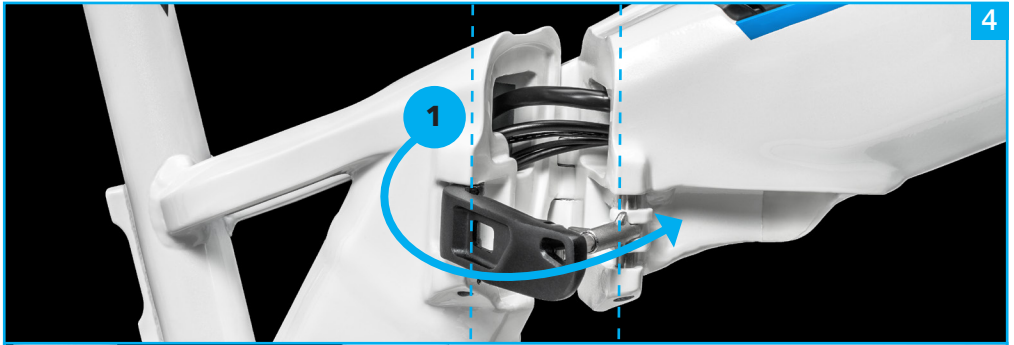

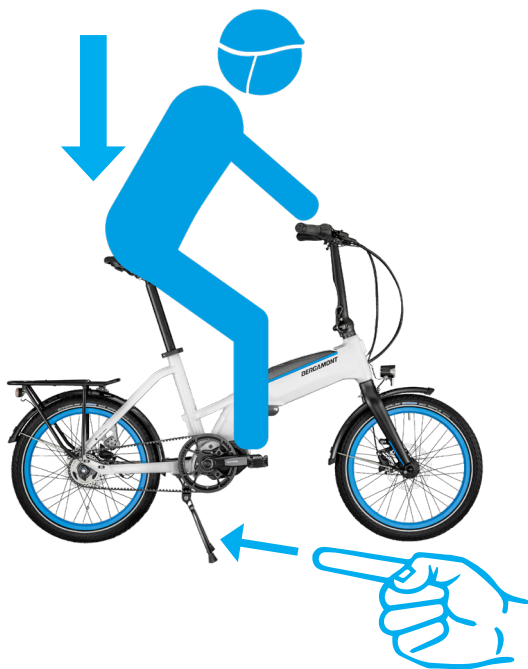
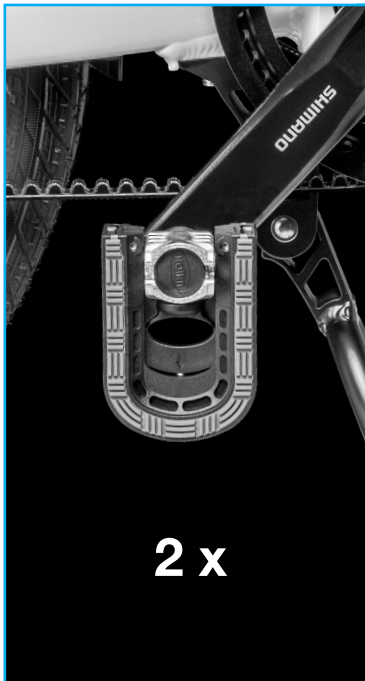





STRAIGHT FROM ST. PAULI

All rights reserved
© 2020 BERGAMONT Fahrrad Vertrieb GmbH

BERGAMONT
Fahrrad Vertrieb GmbH
Budapester Straße 45
20359 Hamburg // Germany

T + 49 40 43 28 43-0
F + 49 40 43 01 201

info@bergamont.de

 facebook.com/bergamont

 instagram.com/bergamontbicycles

 twitter.com/bergamont

bergamont.com