

***SCOTT***

---

BIKE

**BIKE TRANSPORT BAG  
ROAD / TRI**

USER MANUAL

---

INNOVATION  
TECHNOLOGY  
DESIGN

---

**[WWW.SCOTT-SPORTS.COM](http://WWW.SCOTT-SPORTS.COM)**

# PARTS | TEILE | ÉLÉMENTS

## TRIATHLON FRONT PADS

Vordere Triathlon-Polster  
Protections guidon de Triathlon

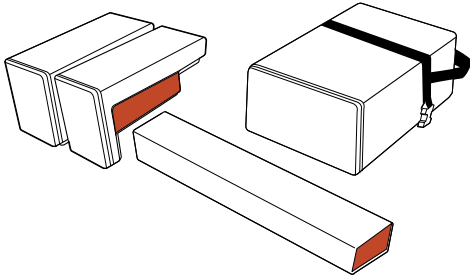

## ROAD/GRAVEL FRONT PADS

Vordere Road/Gravel-Polster  
Protections guidon de Road/Gravel

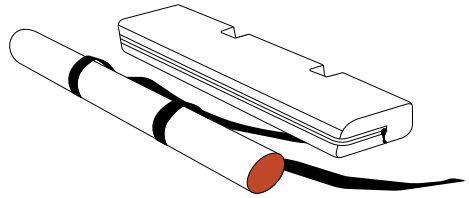

## REAR PAD

Hinteres Polster  
Coussinet arrière

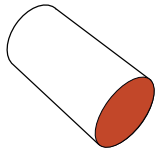

## CHAIN PROTECTOR

Kettenschutz  
Protection de chaîne



## FRAME FIXATION AXES

Rahmenbefestigungsachsen  
Axes de fixation du cadre

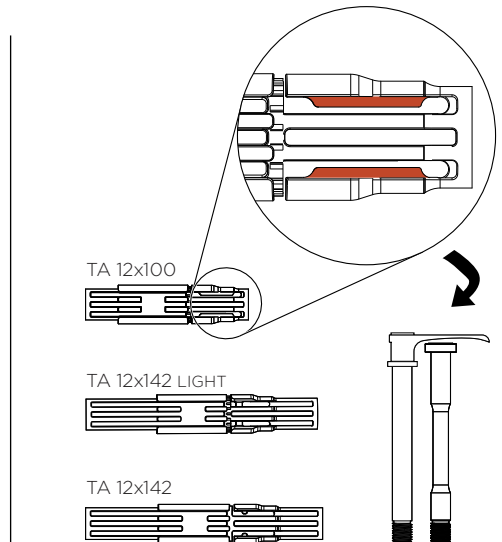
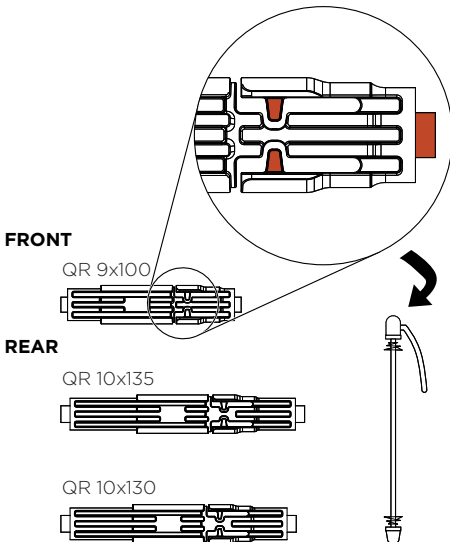

**BIKE STAND**

Fahrradständer  
Fixation du vélo

**PAD FIXATION**

Polsterbefestigung  
Attaches protections

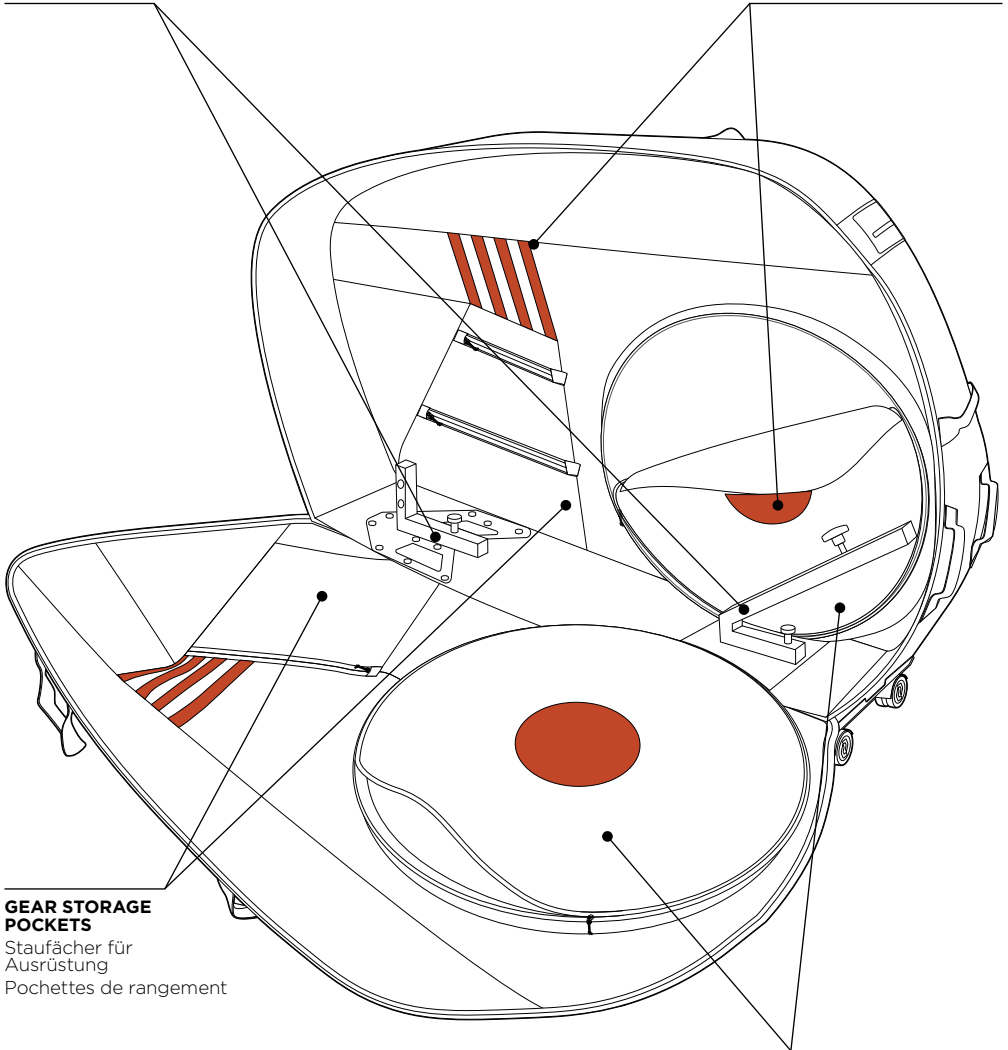

**GEAR STORAGE POCKETS**

Staufächer für  
Ausrüstung  
Pochettes de rangement

**WHEEL POCKETS**

Laufadfächer  
Compartiments pour les roues

# HOW TO MOUNT | AUFBAUANLEITUNG | CONSEILS D'ASSEMBLAGE

## STEP 1 PREPARE THE BIKE

Schritt 1 Fahrrad vorbereiten

Étape 1 Préparez le vélo

### a REMOVE THE PEDALS

Pedale entfernen  
Retirer les pédales

### b REMOVE THE WHEELS

Räder abnehmen  
Retirer les roues

### c LOWER THE SADDLE IF NEEDED

Sattel absenken falls nötig  
Baissez la selle si nécessaire

## STEP 2 SELECT FRONT PADS

Schritt 2 Vordere Polster auswählen

Étape 2 Choisissez la mousse pour l'avant

### CHOOSE BETWEEN TRIATHLON AND ROAD/GRAVEL PADS

Zwischen Triathlon- und Strassen-/Gravel-Polster entscheiden

Choisissez entre les mousses triathlon ou route/gravel

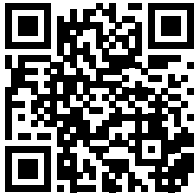

### SCAN FOR MORE INSTRUCTIONS

QR Code scannen um mehr zu erfahren

Scannez pour plus d'information

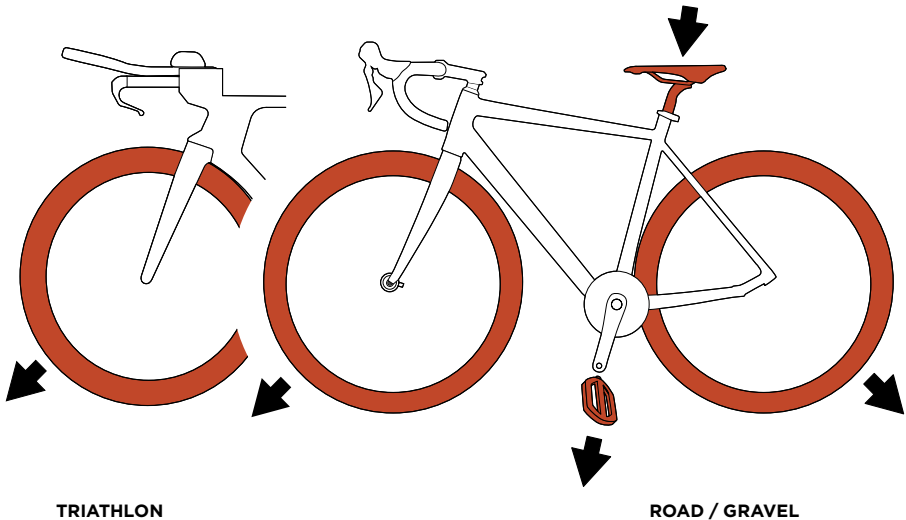

**STEP 3a** FIX THE TRIATHLON PADS WITH THE STRAPS

Schritt 3a Triathlon-Polster mit den Riemen befestigen

Étape 3a Fixez les renforts de Triathlon avec les straps

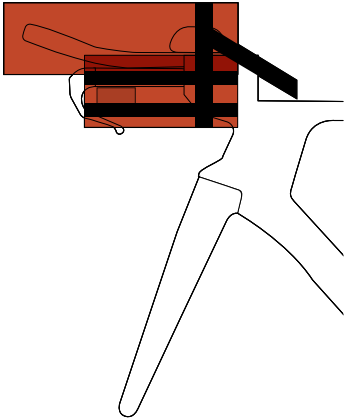

**SIDE VIEW** | Seitenansicht | Vue de côté

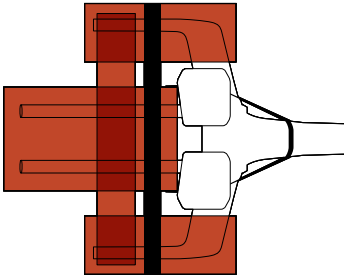

**TOP VIEW** | Draufsicht | Vue de haut

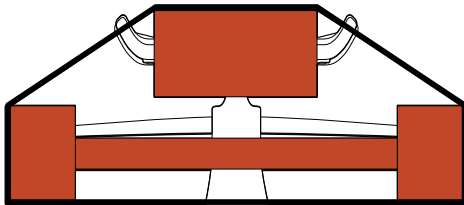
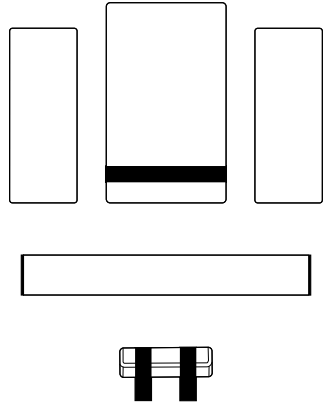

**FRONT VIEW** | Frontansicht | Vue de devant

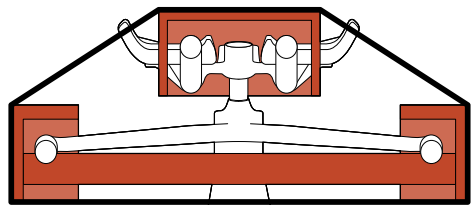

**REAR VIEW** | Rückansicht | Vie de l'arrière

**STEP 3b FIX THE ROAD/GRAVEL PADS WITH THE STRAPS**

Schritt 3b Strassen-/Gravel-Polster mit den Riemen befestigen

Étape 3b Fixer les renforts de route/gravel avec les straps

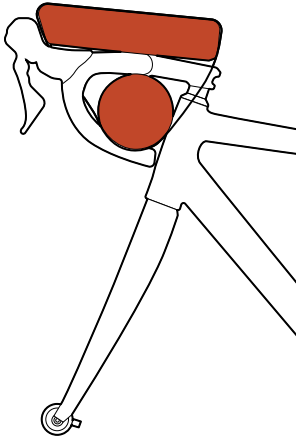

**SIDE VIEW** | Seitenansicht | Vue de côté

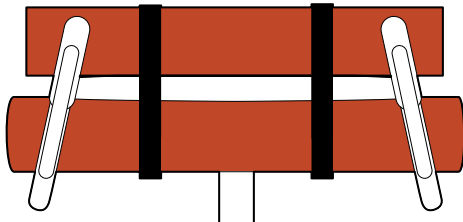
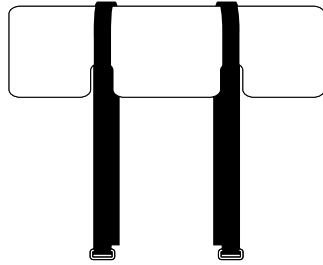
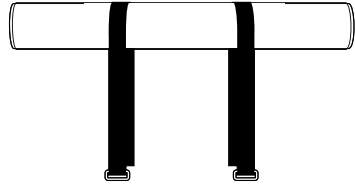

**FRONT VIEW** | Frontansicht | Vue de devant

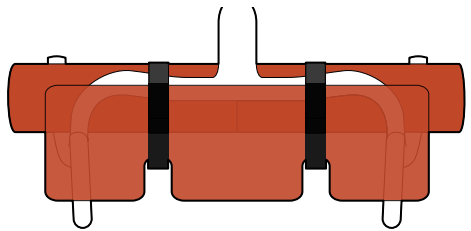

**TOP VIEW** | Draufsicht | Vue de haut

**STEP 4 FIX FRAME AND STORE PARTS**

Schritt 4 Rahmen befestigen und Teile verstauen

Étape 4 Fixez le cadre et rangez les accessoires

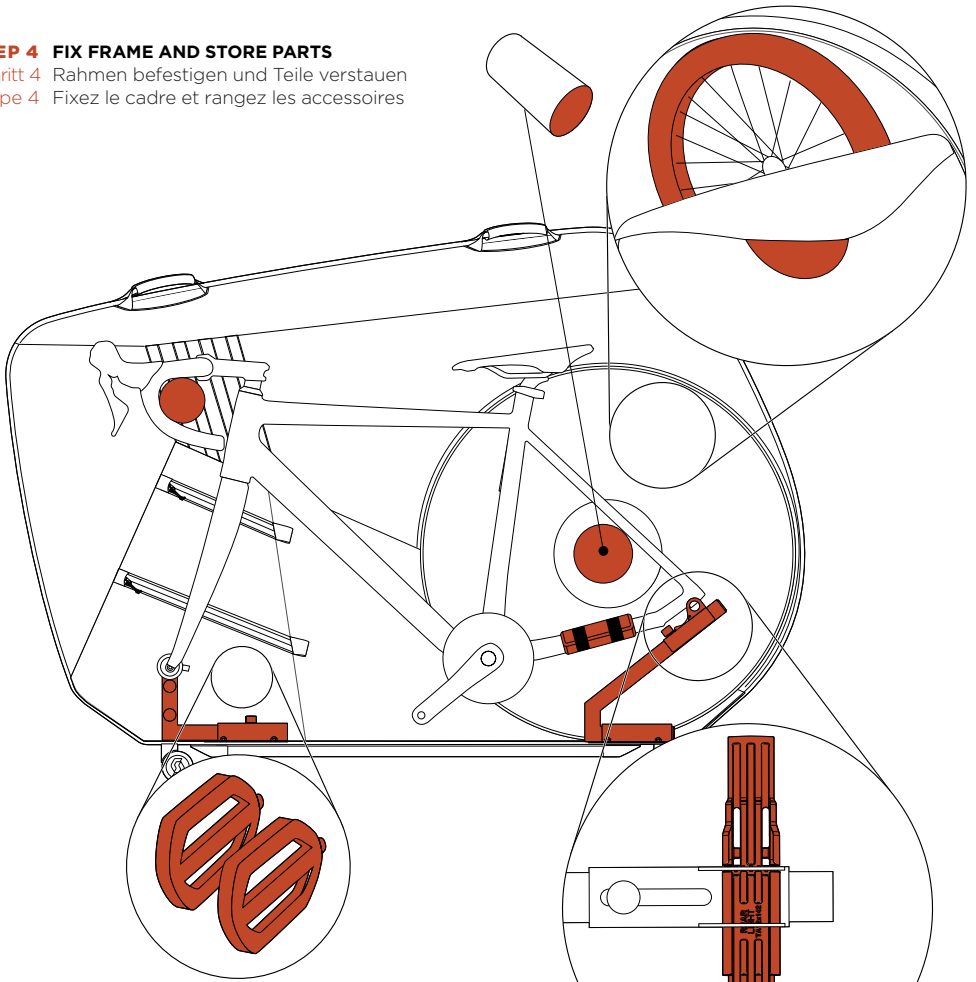

**HOW TO LOCK** | Wie zusammensetzen | Comment bloquer

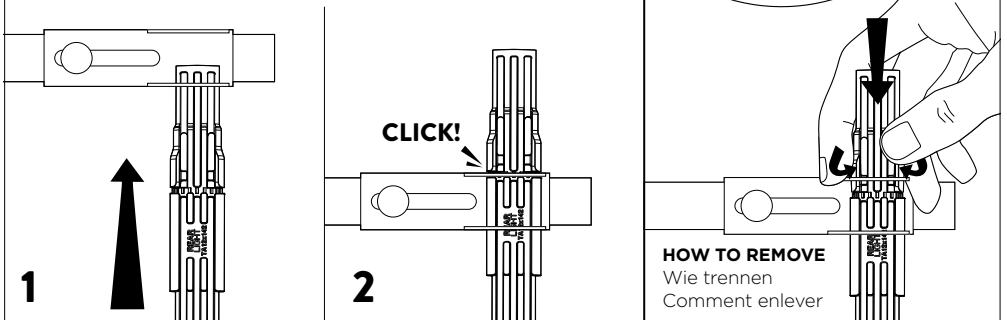

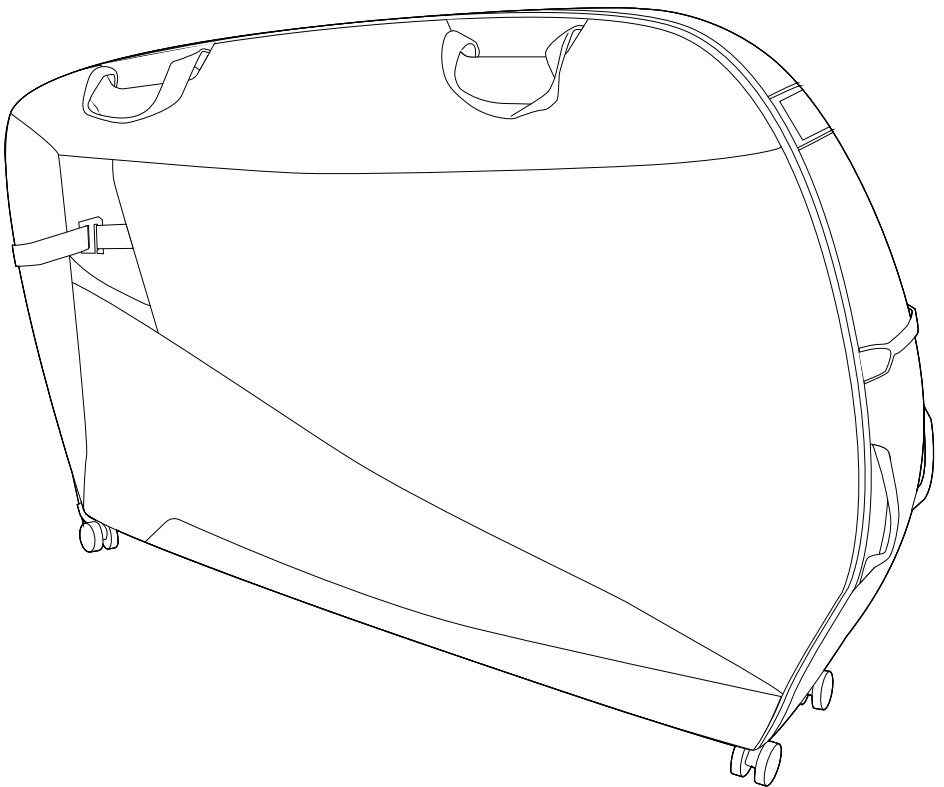

**WWW.SCOTT-SPORTS.COM**

©SCOTT SPORTS SA 2022. All rights reserved. Rev. 01 of 09.2022. The information contained in this manual is in various languages but only the English version will be relevant in case of conflict.

©SCOTT SPORTS SA 2022. Alle Rechte vorbehalten. Rev. 01 vom 09.2022. Die in dieser Bedienungsanleitung enthaltenen Informationen sind zwar auf verschiedenen Sprachen erhältlich, im Streitfalle ist aber lediglich die englische Version massgeblich.

©SCOTT SPORTS SA 2022. Tous droits réservés. Rev. 01 du 09.2022. Les informations contenues dans ce manuel ont été traduites en plusieurs langues. Seule la langue anglaise fera foi en cas de litiges.